

TOP VIEW

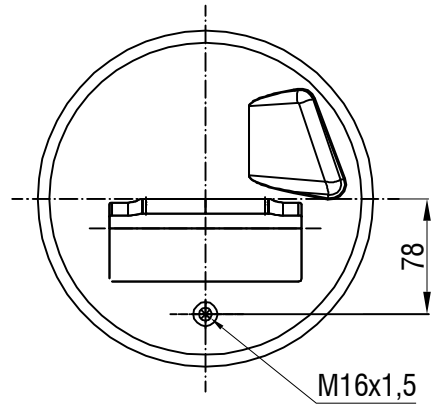

Drawings are prepared for catalogue study.

↑ Changes	0	First drawing	13.11.2013			
	Issue	Changes	Date	Drawn by	Checked by	Approved by
PART WEIGHT:	Do not scale this drawing	<input checked="" type="checkbox"/> Bolt/Stud	<input checked="" type="checkbox"/> Combo stud	<input checked="" type="checkbox"/> Air inlet	<input checked="" type="checkbox"/> Threaded hole	
...Kg.	<small>All rights of this document are the property of AKTAS A.S. It can not be used copied, reproduced, made available to any third party in whole or part without written permission of AKTAS A.S.</small>				ORDER NO:121632	
PART NAME:	36686 P SERVICE ASSEMBLY (AIRTECH)				